

V Valves

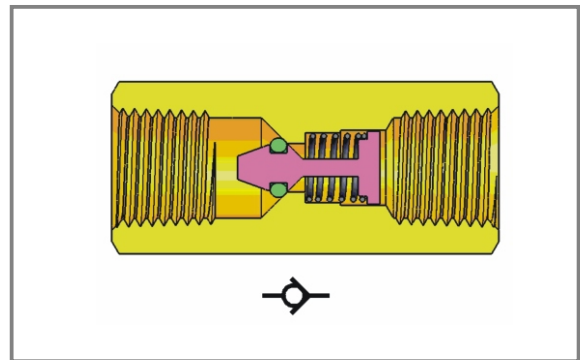

V series
Valves
閥系列

V Valves 閥系列

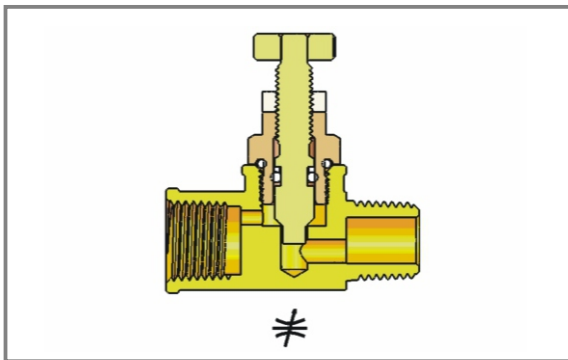
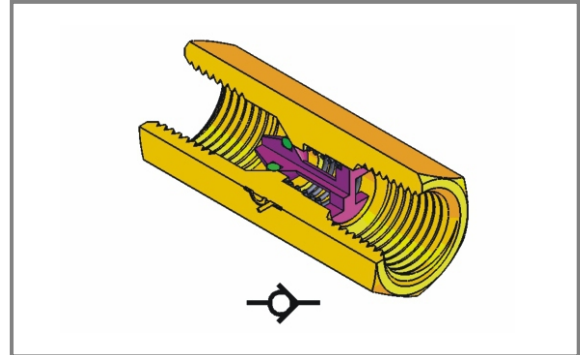
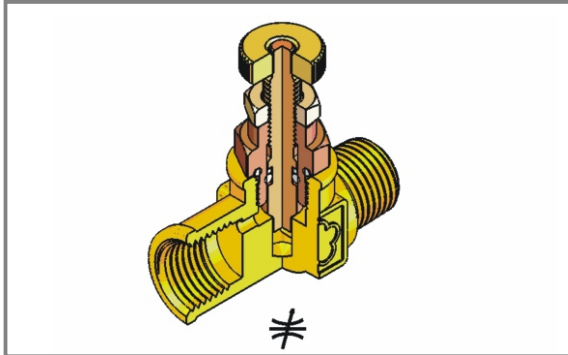

特點

管牙有BSPT(R)及NPT兩種。

材質

接頭、中心止針均採用黃銅JIS3604材質加工而成。
鍛造主體採用黃銅JIS3771材質鍛造並加工而成。

工作溫度

-53°C~ 121°C

工作壓力

最大70 bar的壓力使用。

組裝步驟

依A/E管牙系列之管牙組裝方式組裝。

Characteristic

Pipe thread includes BSPT(R) and NPT

Material

All connectors, needles are machined from brass JIS3604
All forging body are forged and machined from brass JIS3771

Working Temperature

From -65°F~250°F

Working Pressure

1000 PSI maximum

Assembly Instruction

As the way of A/E Pipe thread fittings

V01

流量調節閥 Flow Control Valve

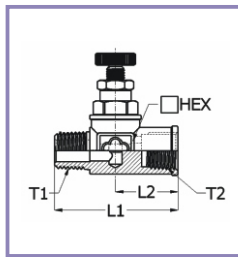

產品編號	管牙 T1	內管牙 T2	L1	L2	HEX
PART NO.	PipeThread T1	PipeThread T2			
V01-C202	1/4	1/4	43	21.5	17

V02

雙外牙逆止閥 Male Union Check Valve

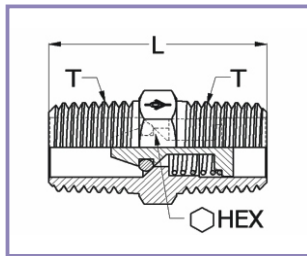

產品編號	管牙 T	L	HEX
PART NO.	PipeThread T		
V02-C202	1/4	29	14

V03

雙內牙逆止閥 Female Union Check Valve

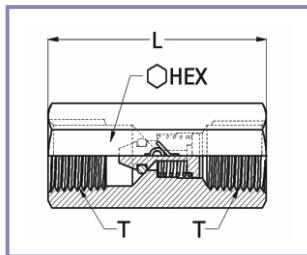

產品編號	內管牙 T	L	HEX
PART NO.	PipeThread T		
V03-C202	1/4	44	17

V04

中止開關 On/Off Valve

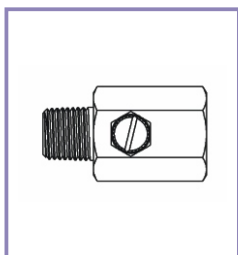
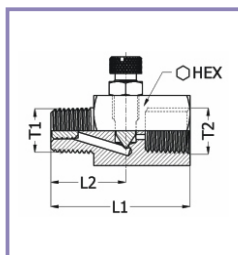

產品編號	管牙 T1	管牙 T2	L1	L2	HEX
PART NO.	PipeThread T1	PipeThread T2			
V04-C202	1/4	1/4	43	23.6	21